

Pro-face

by Schneider Electric

SCIENCE
GATE
Your Automation Partner



SCIGATE AUTOMATION (S) PTE LTD

No.1 Bukit Batok Street 22 #01-01 Singapore 659592

Tel: (65) 6561 0488

Fax: (65) 6562 0588

Email: sales@scigate.com.sg

Web: www.scigate.com.sg

Business Hours: Monday - Friday 8.30am - 6.15pm

GP4000 Series Installation Guide



Please read the “Warning/Caution Information” on the attached sheet before using the product.

NOTE: This Installation Guide describes GP4000 Series except GP-4100 Series, GP-4201TM and GP-4301TM.

Overview

Package Contents.....	4
About the Manual.....	5
Global Code.....	5

Electrical Specifications

1. GP-4200/4300/4400 Series	6
2. GP-4500/4600 Series	7

Part Numbers and Functions

1. GP-4200 Series	8
2. GP-4300 Series	9
3. GP-4400 Series	10
4. GP-4500 Series	11
5. GP-4600 Series	12
6. LED Indications.....	13

Interface

Serial Interface.....	14
-----------------------	----

Installation

1. Installation Requirements	19
2. Installation Procedure	20
3. Removal Procedures	23

Wiring

Wiring.....	25
-------------	----

USB Clamp

USB Clamp	31
-----------------	----

Standards

Relevant Standards	33
--------------------------	----

Package Contents

The following items are included in the package. Before using the GP unit, please confirm that all items listed here are present:

- 1 GP unit: 1
- 2 Installation gasket: 1 (attached to the GP unit)
- 3 Installation fasteners: 4 per set
- 4 DC power supply connector: 1 (only for DC type)
- 5 USB clamp: 1 set (1 clip and 1 tie)
- 6 GP4000 Series Installation Guide (this guide): 1
- 7 Warning/Caution Information: 1

1

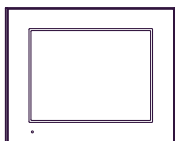

2



3

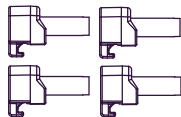

4

For
GP-4200/4300/4400 Series

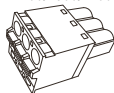

For
GP-4500/4600 Series

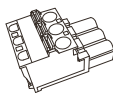

5

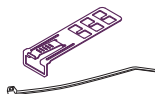

This unit has been carefully packed, with special attention to quality. However, should you find anything damaged or missing, please contact your local GP unit distributor immediately.

About the Manual

This manual describes wiring and installation procedures. For more detailed information, refer to the GP4000 Series Hardware Manual.

You can download the manual from our support site at
<http://www.pro-face.com/trans/en/manual/1001.html>

Global Code

A global code is assigned to every Pro-face product as a universal model number.

For more information on product models and their matching global codes, please refer to the following URL.

<http://www.pro-face.com/trans/en/manual/1003.html>

1. GP-4200/4300/4400 Series

Specification		GP-4200 Series	GP-4300 Series	GP-4400 Series
Power Supply	Rated Input Voltage	24 Vdc		
	Input Voltage Limits	19.2...28.8 Vdc		
	Voltage Drop	2 ms or less	5 ms or less	
	Power Consumption	9.6 W or less	10.5 W or less	12 W or less
	When power is not supplied to external devices	5.2 W or less	6.5 W or less	8 W or less
	Backlight is OFF (Standby Mode)	4.2 W or less	4.5 W or less	5 W or less
	Backlight Dimmed (Brightness: 20%)	4.3 W or less	5 W or less	5.5 W or less
In-Rush Current	30 A or less			
Voltage Endurance	1,000 Vac, 20 mA for 1 min (between charging and FG terminals)			
Insulation Resistance	500 Vdc, 10 MΩ or more (between charging and FG terminals)			

2. GP-4500/4600 Series

Specification		GP-4500/4600 Series		
		DC Model	AC Model	
Power Supply	Rated Input Voltage	24 Vdc	100...240 Vac	
	Input Voltage Limits	19.2...28.8 Vdc	85...264 Vac	
	Rated Frequency	-	50/60 Hz	
	Rated Frequency Range	-	47...63 Hz	
	Voltage Drop	10 ms or less	1 cycle or less (Voltage drop interval must be 1 second or more)	
	Power Consumption		17 W or less	100 Vac: 44 VA or less 240 Vac: 58 VA or less
		When power is not supplied to external devices	12 W or less	100 Vac: 30 VA or less 240 Vac: 44 VA or less
		Backlight OFF (Standby Mode)	7 W or less	100 Vac: 18 VA or less 240 Vac: 29 VA or less
		Backlight Dimmed (Brightness: 20%)	8 W or less	100 Vac: 22 VA or less 240 Vac: 31 VA or less
	In-Rush Current	30 A or less		
Voltage Endurance	1,000 Vac, 20 mA for 1 min (between charging and FG terminals)	1,500 Vac 20 mA for 1 min (between charging and FG terminals)		
Insulation Resistance	500 Vdc, 10 MΩ or more (between charging and FG terminals)			

1. GP-4200 Series

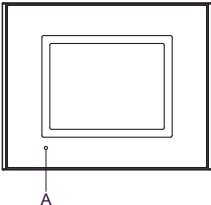
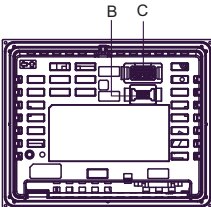
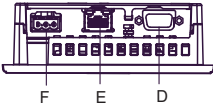
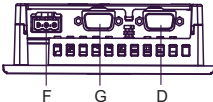
Front	
Rear	
Bottom	<p data-bbox="339 783 497 805">GP-4201T/4203T</p>  <p data-bbox="339 968 461 990">GP-4201TW</p> 

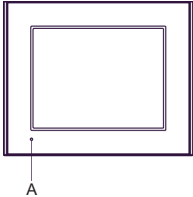
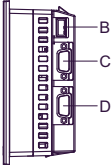
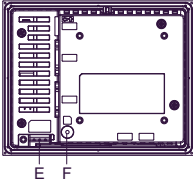
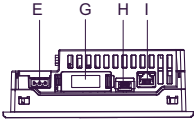

- A: Status LED (see page.13)
- B: USB (mini-B) Interface
- C: USB (Type A) Interface
- D: Serial Interface (COM1)
- E: Ethernet Interface (see page.13)
- F: Power Plug Connector
- G: Serial Interface (COM2)

2. GP-4300 Series

Front	
Right	
Rear	
Bottom	

- A: Status LED (see page. 13)
- B: USB (Type A) Interface
- C: Serial Interface (COM1)
- D: Serial Interface (COM2)
- E: Power Plug Connector
- F: SD Card Access LED (except GP-4301TW) (see page.13)
- G: SD Card Interface Cover/Replacement Battery Insertion Cover (except GP-4301TW)
- H: USB (mini-B) Interface
- I: Ethernet Interface (see page.13)

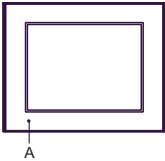
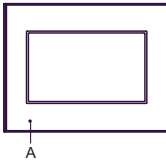
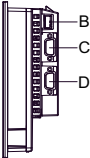
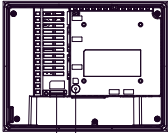
3. GP-4400 Series

Front	<div style="display: flex; justify-content: space-around;"> <div style="text-align: center;"> <p>GP-4401T</p>  <p>A</p> </div> <div style="text-align: center;"> <p>GP-4401WW</p>  <p>A</p> </div> </div>
Right	 <p>B C D</p>
Rear	 <p>E F</p>
Bottom	 <p>E G H I</p>

A: Status LED (see page.13)

B: USB (Type A) Interface

C: Serial Interface (COM1)

D: Serial Interface (COM2)

E: Power Plug Connector

F: SD Card Access LED (see page.13)

G: SD Card Interface Cover/Replacement Battery Insertion Cover

H: USB (mini-B) Interface

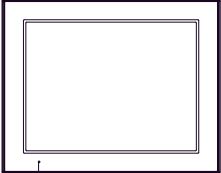
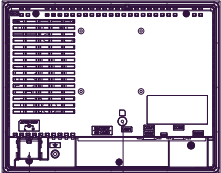
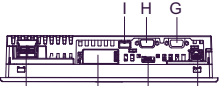

I: Ethernet Interface (see page.13)

4. GP-4500 Series

Front	 <p>A</p>
Rear	 <p>B C</p>
Bottom	 <p>B F E D I H G</p>

- A: Status LED (see page.13)
- B: Power Input Terminal Block (AC model),
Power Plug Connector (DC model)
- C: SD Card Access LED (see page.13)
- D: Ethernet Interface (see page.13)
- E: USB (mini-B) Interface
- F: SD Card Interface Cover/Replacement Battery Insertion Cover
- G: Serial Interface (COM2)
- H: Serial Interface (COM1)
- I: USB (Type A) Interface

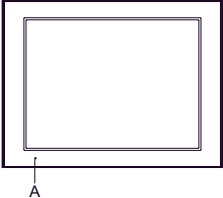
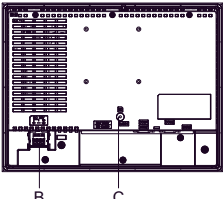
5. GP-4600 Series

Front	
Rear	
Bottom	

- A: Status LED (see page.13)
- B: Power Input Terminal Block (AC model),
Power Plug Connector (DC model)
- C: SD Card Access LED (see page.13)
- D: Ethernet Interface (see page.13)
- E: USB (mini-B) Interface
- F: SD Card Interface Cover/Replacement Battery Insertion Cover
- G: Serial Interface (COM2)
- H: Serial Interface (COM1)
- I: USB (Type A) Interface

6. LED Indications

(1) Status LED

Color	Indicator	Operation Mode (Drawing)	Logic execution mode (when logic is enabled)*1
Green	ON	Offline	-
		In operation	RUN
	Flashing	In operation	STOP
Orange	Flashing	Software starting up	
Red	ON	Power is turned ON.	
	Flashing	In operation	Major Error
LED fade (Green)*1	ON	The GP unit's "Backlight Control" is set to Standby Mode and the screen has gone blank.	
-	OFF	Power is turned OFF.	

*1 Make sure your screen editing software supports the function.

(2) SD Card access LED

Color	Indicator	Description
Green (Active)	ON	The SD Card is inserted.
	OFF	The SD Card is not inserted or is not being accessed.

(3) Ethernet LED

	Color	Indicator	Description
	Green (Active)	Flashing	Data transmission is occurring.
		OFF	No data transmission
	Green (Link)	ON	Data transmission is available in 10BASE-T/100BASE-TX.
		OFF	No connection or subsequent transmission is NOT available.

Serial Interface

Note: For information on how to connect controllers and other types of equipment, refer to the corresponding device driver manual of your screen editing software.



ELECTRIC SHOCK

The serial port is not isolated. The SG (signal ground) and the FG (frame ground) terminals are connected inside the unit. When using the SG terminal to connect an external device to the unit:

- Verify that a short-circuit loop is not created when you set up the system.
- Connect the #5 SG terminal to remote equipment when the host (PLC) unit is not isolated. Connect the #5 SG terminal to a known reliable ground connection to reduce the risk of damaging the RS-232C/RS422/RS485 circuit.

Failure to follow these instructions will result in death or serious injury.



LOSS OF COMMUNICATION

- All connections to the communication ports must not put excessive stress on the ports.
- Securely attach communication cables to the panel wall or cabinet.

Failure to follow these instructions can result in injury or equipment damage.

1. Connection for Serial Interface

Pin assign of each serial interface is explained in reference page.

	COM1	COM2
GP-4201T	RS-232C or RS-422/RS-485 (see page.16, 17)	-
GP-4201TW	RS-232C (see page.16)	RS-422/RS-485 (see page.17)
GP-4203T	RS-485 (isolation) (see page.18)	-
GP-4301T	RS-232C (see page.16)	RS-422/RS-485 (see page.17)
GP-4301TW	RS-232C (see page.16)	RS-422/RS-485 (see page.17)
GP-4303T	RS-232C (see page.16)	RS-485 (isolation) (see page.18)
GP-4401T	RS-232C (see page.16)	RS-422/RS-485 (see page.17)
GP-4401WW	RS-232C (see page.16)	RS-422/RS-485 (see page.17)
GP-4501T	RS-232C (see page.16)	RS-422/RS-485 (see page.17)
GP-4501TW	RS-232C (see page.16)	RS-422/RS-485 (see page.17)
GP-4503T	RS-232C (see page.16)	RS-485 (isolation) (see page.18)
GP-4601T	RS-232C (see page.16)	RS-422/RS-485 (see page.17)
GP-4603T	RS-232C (see page.16)	RS-485 (isolation) (see page.18)

2. RS-232C

D-Sub 9 pin plug connector via an RS-232C cable.

Pin Number	RS-232C		
	Signal Name	Direction	Meaning
1	CD	Input	Carrier Detect
2	RD(RXD)	Input	Receive Data
3	SD(TXD)	Output	Send Data
4	ER(DTR)	Output	Data Terminal Ready
5	SG	–	Signal Ground
6	DR(DSR)	Input	Data Set Ready
7	RS(RTS)	Output	Request to Send
8	CS(CTS)	Input	Send Possible
9	CI(RI)/VCC	Input/–	Called Status Display +5 V \pm 5 % Output 0.25 A ^{*1}
Shell	FG	–	Frame Ground (Common with SG)

*1 You can switch pin #9 between RI and VCC via software. To prevent damage or a unit malfunction, use only the rated current.

Interfit bracket is #4-40 (UNC).

Recommendations:

- Cable Connector: XM2D-0901 manufactured by OMRON Corporation.
- Cable Cover: XM2S-0913 manufactured by OMRON Corporation.
- Jack Screw (#4-40 UNC): XM2Z-0073 manufactured by OMRON Corporation.

3. RS-422/485

D-Sub 9 pin plug connector via an RS-422/485 cable.

Pin Number	RS-422/RS-485		
	Signal Name	Direction	Meaning
1	RDA	Input	Receive Data A (+)
2	RDB	Input	Receive Data B (-)
3	SDA	Output	Send Data A (+)
4	ERA	Output	Data Terminal Ready A (+)
5	SG	-	Signal Ground
6	CSB	Input	Send Possible B (-)
7	SDB	Output	Send Data B (-)
8	CSA	Input	Send Possible A (+)
9	ERB	Output	Data Terminal Ready B (-)
Shell	FG	-	Frame Ground (Common with SG)

Interfit bracket is #4-40 (UNC).

Recommendations:

- Cable Connector: XM2D-0901 manufactured by OMRON Corporation.
- Cable Cover: XM2S-0913 manufactured by OMRON Corporation.
- Jack Screw (#4-40 UNC): XM2Z-0073 manufactured by OMRON Corporation.

4. RS-485 (isolation)

D-Sub 9 pin socket connector via an RS-485/PROFIBUS/MPI cable.

Pin Number	RS-485 (isolation)		
	Signal Name	Direction	Meaning
1	NC	–	no connection
2	NC	–	no connection
3	Line A	Input/Output	Data A (+)
4	RS(RTS)	Output	Request to Send
5	SG	–	Signal Ground
6	VCC	–	+5 V \pm 5 % External Output ^{*1}
7	NC	–	no connection
8	Line B	Input/Output	Data B (–)
9	NC	–	no connection
Shell	FG	–	Frame Ground ^{*2} (Not connected with SG)

*1 You can supply power to the Siemens PROFIBUS connector only.
You cannot supply power to the device/PLC.

*2 The SG and FG terminals are isolated.

Interfit bracket is #4-40 (UNC).

Recommendations:

- Cable Connector: XM2A-0901 manufactured by OMRON Corporation.
- Cable Cover: XM2S-0913 manufactured by OMRON Corporation.
- Jack Screw (#4-40 UNC): XM2Z-0073 manufactured by OMRON Corporation.

1. Installation Requirements

- Decide on the thickness of the enclosure wall, based on the level of strength required: 1.6 mm (0.06 in) to 5 mm (0.2 in).
- Even if panel thickness is within recommend range for “Panel Cut Dimensions”, the panel could warp, depending on panel’s material, size, and installation location of GP unit or other devices. To prevent panel warpage, the installation surface may need to be strengthened.
- Check that the installation panel or cabinet’s surface is flat, in good condition and has no jagged edges.
- Be sure that the surrounding air temperature and the ambient humidity are within their designated ranges. Surrounding air temperature:
 0 to 50 °C (32 to 122 °F): GP-4200 Series, GP-4301TW, GP-4401WW, and GP-4501TW DC models.
 0 to 55 °C (32 to 131 °F): GP-4301T, GP-4303T, GP-4401T, GP-4501T/4503T DC models, GP-4500 Series AC models, and GP-4600 Series.
 ambient humidity: 10 to 90 %RH; wet bulb temperature: maximum 39 °C (102 °F). When installing the GP unit in a cabinet or enclosure, the surrounding air temperature is the cabinet’s or enclosure’s internal temperature.

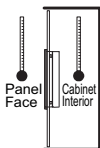

- Be sure that heat from surrounding equipment does not cause the GP unit to exceed its standard operating temperature.
- When mounting the GP unit vertically, ensure that the right side of the unit faces up. In other words, the power connector for DC model, power terminal block for AC model, should be at the top.

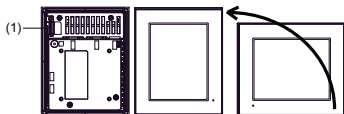

(1) Power Connector, or power terminal block

Note : For vertical mounting, make sure your screen editing software supports the function.

- When installing the GP unit in a slanted position, the GP unit face should not incline more than 30 °.

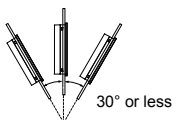

Installation

- When installing the GP unit in a slanted position with an incline more than 30°, the ambient temperature must not exceed 40 °C (104 °F). You may need to use forced air cooling (fan, A/C) to ensure the ambient operating temperature is 40 °C or less (104 °F or less).
- For easier maintenance, operation and improved ventilation, install the GP unit at least 100 mm (3.94 in) away from adjacent structures and other equipment as shown in the following illustration.

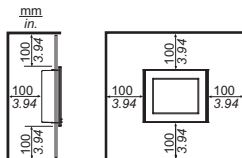

- The holes on the rear of the GP unit (except GP-4200 Series) are not correspondent with VESA 75 mm standards. Do not attach the GP unit to the commercial-type VESA arm.

2. Installation Procedure

NOTICE

PANEL UNSTEADY WHEN UNSECURED

Keep GP unit stabilized in the panel-cut while you are installing or removing the screw fasteners.

Failure to follow the instruction can result in equipment damage.

Step	Action
1	Place the GP unit on a clean and level surface with the display facing downward.
2	<p>Check that the GP unit's gasket is seated securely into the gasket's groove, which runs around the perimeter of the panel frame.</p> <p>Note: It is strongly recommended that you use the installation gasket, since it absorbs vibration in addition to repelling water. For the procedure for replacing the installation gasket, refer to "GP4000 Series Hardware Manual".</p>

- 3 Create a Panel Cut and insert the GP into the panel from the front.

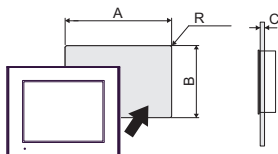

GP-4200 Series

A	B	C	R
118.5 ⁺¹ ₋₀ mm (4.67 ^{+0.04} ₋₀ in)	92.5 ⁺¹ ₋₀ mm (3.64 ^{+0.04} ₋₀ in)	1.6...5 mm (0.06...0.2 in)	3 mm (0.12 in) maximum

GP-4300 Series

A	B	C	R
156 ⁺¹ ₋₀ mm (6.14 ^{+0.04} ₋₀ in)	123.5 ⁺¹ ₋₀ mm (4.86 ^{+0.04} ₋₀ in)	1.6...5 mm (0.06...0.2 in)	3 mm (0.12 in) maximum

GP-4400 Series

A	B	C	R
204.5 ⁺¹ ₋₀ mm (8.05 ^{+0.04} ₋₀ in.)	159.5 ⁺¹ ₋₀ mm (6.28 ^{+0.04} ₋₀ in)	1.6...5 mm (0.06...0.2 in)	3 mm (0.12 in) maximum

GP-4500 Series

	A	B	C	R
GP-4501T GP-4503T	259 ⁺¹ ₋₀ mm (10.2 ^{+0.04} ₋₀ in)	201 ⁺¹ ₋₀ mm (7.91 ^{+0.04} ₋₀ in)	1.6...5 mm (0.06...0.2 in)	3 mm (0.12 in) maximum
GP-4501TW	301.5 ⁺¹ ₋₀ mm (11.87 ^{+0.04} ₋₀ in)	227.5 ⁺¹ ₋₀ mm (8.96 ^{+0.04} ₋₀ in)		

GP-4600 Series

A	B	C	R
301.5 ⁺¹ ₋₀ mm (11.87 ^{+0.04} ₋₀ in)	227.5 ⁺¹ ₋₀ mm (8.96 ^{+0.04} ₋₀ in)	1.6...5 mm (0.06...0.2 in)	3 mm (0.12 in) maximum

- 4 Insert the installation fasteners into the GP unit's insertion slots on the top and bottom sides. (left and right sides for the GP-4200 Series.) If the fasteners are not correctly attached, the GP unit may shift or fall out.

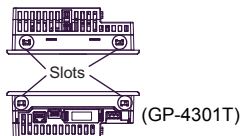
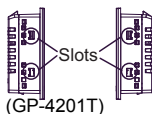
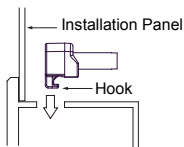

- 5 Slide the fasteners to the back.

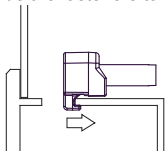

- 6 Use a Phillips screwdriver to tighten each fastener screw and secure the GP unit in place. The necessary torque is 0.5 Nm (4.4 lb-in).

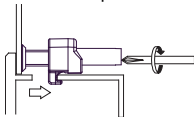

NOTICE

BROKEN ENCLOSURE

- Do not exert more than 0.5 Nm (4.4 lb-in) of torque when tightening the fastener's screws.
- For use on a flat surface of a Type 1, Type 4X (Indoor Use Only) or Type 13 Enclosure.

Failure to follow these instructions can result in equipment damage.

3. Removal Procedures

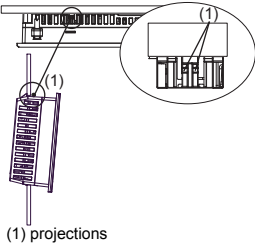
Step	Action
1	Loosen the installation fasteners (4) from the GP unit.
2	<p>Remove the GP unit slowly from the panel while pressing the projections on the top of the GP unit.</p>  <p style="text-align: center;">(1) projections</p> <p>Note :</p> <ul style="list-style-type: none"> • You could damage the GP unit if you try and remove it without holding down the projections. • Watch your fingers so they do not get caught when holding down the projections.

 **CAUTION**

RISK OF INJURY

Do not drop the GP unit when you remove it from the panel.

- Hold the GP unit in place after removing the fasteners.
- Use both hands.

Failure to follow the instruction can result in injury or equipment damage.

Wiring

WARNING

HAZARD OF ELECTRIC SHOCK, EXPLOSION OR ARC FLASH

- Remove all power from the device before removing any elements of the system, and prior to installing or removing any accessories, hardware, or cables.
- Remove power before wiring the GP unit's power terminals.
- The DC model uses only 24 Vdc power. Using any other level of power can damage both the power supply and the GP unit.
- The AC model is designed to use 100 Vac to 240 Vac input. Using any other level of power can damage both the power supply and the GP unit.
- Since the GP unit is not equipped with a power switch, be sure to connect a power switch to the power supply.
- Be sure to ground the GP unit's FG terminal.
For AC models, use the following torque to tighten the terminals:
 - Terminal Block: 1.4 N•m (12.4 lb-in)
 - Functional Ground (FG) Terminal: 1.4 N•m (12.4 lb-in)
- Replace and secure all elements of the system before applying power to the GP unit.

Failure to follow these instructions can result in death, serious injury, or equipment damage.

Note:

- The shield ground (SG) and FG terminals are connected internally in the GP unit.
- When the functional ground (FG) terminal is connected, be sure the wire is grounded. Not grounding the GP unit can result in excessive Electromagnetic Interference (EMI). Grounding is required to meet EMC level immunity.

1. Connecting the AC Power Cord

Field wiring terminal marking for wire type (75 °C [167 °F] Copper conductors only)

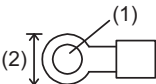
	AC Power Cord	Grounding Wire
Power Cord	Double-insulated Wire 0.75 to 3.5 mm ² (18-12AWG)	0.75 to 3.5 mm ² (18-12AWG)
Recommended Ring Terminal* ¹	J.S.T Mfg. Co., Ltd Compatible: V1.25-M4 (18-16AWG) V2-P4 (16-14AWG) V5.5-S4 (14-12AWG)  (1) $\phi 4.3$ mm (0.17 in) or more (2) Less than 7.2 mm (0.28 in)	J.S.T Mfg. Co., Ltd Compatible: V1.25-M4 (18-16AWG) V2-P4 (16-14AWG) V5.5-S4 (14-12AWG)  (1) $\phi 4.3$ mm (0.17 in) or more (2) Less than 7.2 mm (0.28 in)

*1 To prevent a short circuit caused by loose screws, use a crimp-type terminal with an insulating sleeve.

How to connect the AC Power Cord

Step	Action
1	Confirm the power cord is not connected to the power supply.
2	Open the terminal strip's clear plastic cover.

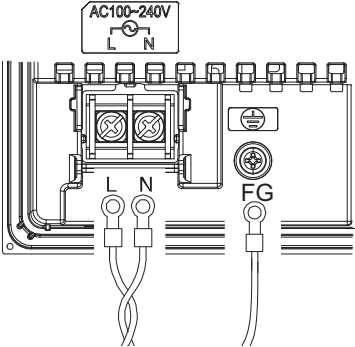
3	<p>Remove screws from the L, N, and FG (functional ground) terminals. Attach the ring terminals and reinsert the screws. Check each wire to make sure the connections are correct.</p> <p>Note :</p> <ul style="list-style-type: none"> • Terminal Block: 1.4 N•m (12.4 lb-in) • FG (functional ground) Terminal: 1.4 N•m (12.4 lb-in)  <p>The diagram shows a terminal block with a label 'AC100-240V' and a power symbol. Below the label are terminals for 'L' (Line) and 'N' (Neutral). To the right are terminals for 'FG' (Functional Ground). Wires are shown connected to these terminals. A ground symbol is also present on the right side of the terminal block.</p>
4	Close the terminal strip's clear plastic cover.

2. Connecting the DC Power Cord

Field wiring terminal marking for wire type (75 °C [167 °F] Copper conductors only)

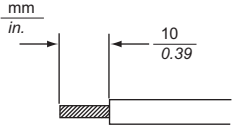
Power Cord Diameter	0.75 to 2.5 mm ² (18-13 AWG)
Conductor type	Simple or Stranded Wire* ¹
Conductor length	 <p>The diagram shows a cross-section of a conductor with a hatched area representing the stripped length. A vertical line with an arrow points to the left, labeled 'mm' above and 'in.' below. A horizontal line with an arrow points to the right, labeled '10' above and '0.39' below.</p>

*1 If the conductor's end (individual) wires are not twisted correctly, the end wires may either short against each other or against an electrode.

Power Connector Specifications: Spring Clamp Terminal Blocks

GP-4200 Series / GP-4300 Series / GP-4400 Series

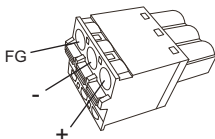

GP-4500 Series / GP-4600 Series

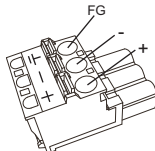

Connection	Wire
+	24 Vdc
-	0 Vdc
FG	Grounded terminal connected to the panel chassis.

Note: The DC power supply connector (plug) for GP-4200/4300/4400 Series is PFZCBCNDC1 (manufactured by Pro-face). The DC power supply connector (plug) for GP-4500 Series / GP-4600 Series is PFZCBCNDC2 (manufactured by Pro-face).

Recommended Driver	SZS 0.6x3.5 (1205053)
Recommended Pin Terminals	3201288 AI 0,75-10 GY 3200182 AI 1 -10 RD 3200195 AI 1,5 -10 BK 3202533 AI 2,5 -10 BU
Recommended Pin Terminal Crimp Tool	CRIMPFOX 6

(Items are made by Phoenix Contact.)

How to connect the DC Power Cord

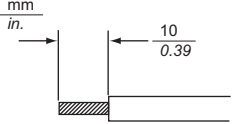
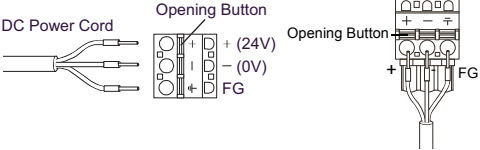
Step	Action
1	Confirm the power cord is not connected to the power supply.
2	Check the rated voltage, and remove the "DC24V" sticker on the DC power supply connector.
3	Remove 10 mm (0.39 in.) of the vinyl membrane off the ends of the power cord wires. 
4	If using stranded wire, twist the ends. Tinning the ends with solder reduces risk of fraying and ensures good electrical transfer.
5	Push the Opening button with a small and flat screwdriver to open the desired pin hole.
6	Insert each pin terminal into its corresponding holder. Release the Opening button to clamp the pin in place. GP-4200 Series / GP-4300 Series / GP-4400 Series GP-4500 Series / GP-4600 Series 
7	After inserting all three pins, insert the DC power supply connector into the power connector on the GP unit.

Note:

- Do not solder the wire directly to the power receptacle pin.
- To prevent the possibility of a terminal short, use a pin terminal that has an insulating sleeve.
- The DC power supply connector for GP-4200/4300/4400 Series can be connected to GP-4500/4600 Series. However, the DC power supply connector for GP-4500/4600 Series is unable to connect to GP-4200/4300/4400 Series.

3. Wiring Cautions

Improving Noise/Surge Resistance

- The GP unit's power supply cord should not be bundled with or kept close to main circuit lines (high voltage, high current), power lines, or input/output lines, and their various systems should be kept separate. When power lines cannot be wired via a separate system, use shielded cables for input/output lines.
- Make the power cord as short as possible, and be sure to twist the ends of the wires together (i.e. twisted pair cabling) from close to the power supply unit.
- If there is an excess amount of noise on the power supply line, connect a noise reducing transistor before turning on the power.
- Connect a surge absorber to handle power surges. Be sure to ground the surge absorber (E1) separately from the GP unit (E2).

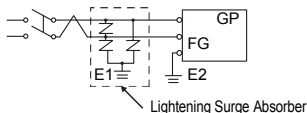

Short Circuit Prevention

- The SG (signal ground) and FG (functional ground) terminals are connected internally in the GP unit. When connecting the SG line to another device, be sure that no shorting loops are formed.

Grounding

- Use an exclusive grounding wire with a grounding resistance of $100\ \Omega$ or less and a wire of $2\ \text{mm}^2$ (AWG 14) or thicker, or your country's applicable standard.

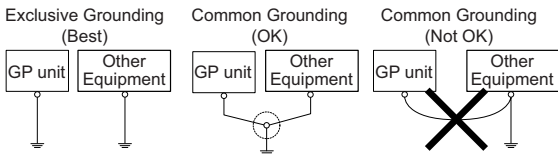

USB Clamp

When using a USB device, attach a USB clamp to the USB interface to prevent the USB cable from being disconnected.

WARNING

RECOMMENDATION FOR RESTRICTED AREAS

- Verify the power, input, and output (I/O) wiring are in accordance with Class I, Division 2 wiring methods.
- Substitution of any component may impair suitability for Class I, Division 2.
- Confirm that the USB cable has been fixed with the USB clamp before using the USB interface.
- Remove power before attaching or detaching any connectors to or from the unit.

Failure to follow these instructions can result in death, serious injury, or equipment damage.

1. Attaching the USB Clamp

Note: Watch your fingers. The edge of the clip is sharp.

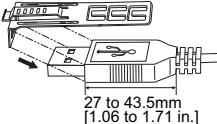
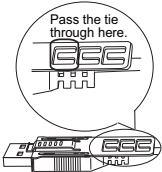
Step	Action
1	<p>Mount the clip to the USB mark  connector shell so that it overlaps. The clip matches the 27 to 43.5 mm (1.06 to 1.71 in) length of the USB connector.</p> 
2	<p>Align the clip and the USB cable connector shell. Adjust the position of the holes where the clip is attached. To ensure stability, select the clip-hole position that is closest to the base of the connector shell.</p> 

- 3 As shown, pass the tie through the clip hole. Next, turn the tie and pass it through the head so that the USB cable can pass through the center of the tie loop. The clip is now attached to the USB cable.

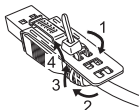
**Note:**

- Check the direction of the head beforehand. Make sure the USB cable is through the center of the tie loop and that the tie can pass through the head.
- You can substitute the tie provided with PFXZCBCLUSA1 (manufactured by Pro-face) or other commercially available ties with a width of 4.8 mm (0.19 in) and thickness of 1.3 mm (0.05 in).

- 4 While pressing the grip on the clip, insert the cable from step 3 all the way into the USB host interface. Make sure that the clip tab is secured to the USB cable attached to the GP unit.

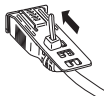

2. Removing the USB Cable

Step	Action
1	Remove the USB cable while pushing the grip section of the clip.

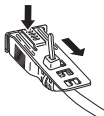

Relevant Standards

For information on certifications and standards, such as certified models and certificates, see the product markings or the following URL:

<http://www.pro-face.com/trans/en/manual/1002.html>

	Names	Registration Model No.
GP-4200 Series	GP-4201T	PFXGP4201TAD
	GP-4201TW	PFXGP4201TADW
	GP-4203T	PFXGP4203TAD
GP-4300 Series	GP-4301T	PFXGP4301TAD PFXGP4301TADC
	GP-4301TW	PFXGP4301TADW PFXGP4301TADWC
	GP-4303T	PFXGP4303TAD
GP-4400 Series	GP-4401T	PFXGP4401TAD
	GP-4401WW	PFXGP4401WADW
GP-4500 Series	GP-4501T (Analog Touch Panel)	PFXGP4501TAA PFXGP4501TAAC
		PFXGP4501TAD PFXGP4501TADC
	GP-4501T (Matrix Touch Panel)	PFXGP4501TMA
		PFXGP4501TMD
	GP-4501TW	PFXGP4501TADW
	GP-4503T	PFXGP4503TAD
GP-4600 Series	GP-4601T (Analog Touch Panel)	PFXGP4601TAA PFXGP4601TAAC
		PFXGP4601TAD PFXGP4601TADC
	GP-4601T (Matrix Touch Panel)	PFXGP4601TMD
		PFXGP4601TMA
	GP-4603T	PFXGP4603TAD

Standards

The GP unit is manufactured in accordance with:

- Standard UL 508 and CSA C22.2 n°142 for Industrial Control Equipment
- Standard ANSI/ISA - 12.12.01 and CSA C22.2 n°213 for Electrical Equipment for Use in Class I, Division 2 Hazardous Locations

Note :

- For use in Pollution Degree 2 environments.
- For use on a flat surface of a Type 1, Type 4X (Indoor Use Only) or Type 13 Enclosure.
- 24V DC input unit must be used with a Class 2 power supply.
- Suitable for use in Class I, Division 2 Groups A, B, C, and D Hazardous Locations.

WARNING

RECOMMENDATION FOR RESTRICTED AREAS

- Verify the power, input, and output (I/O) wiring are in accordance with Class I, Division 2 wiring methods.
- Substitution of any component may impair suitability for Class I, Division 2.
- Do not disconnect equipment while the circuit is live or unless the area is known to be free of ignitable concentrations.
- Securely lock externally connected units and each interface before turning on the power supply.
- The USB (mini-B) interface is for temporary connection only during maintenance and setup of the device. Do not use, connect, or disconnect USB (mini-B) cable unless area is known to be non-hazardous.
- Potential electrostatic charging hazard: wipe the front panel of the terminal with a damp cloth before turning ON.

Failure to follow these instructions can result in death, serious injury, or equipment damage.

CAUTION

ENVIRONMENTAL HAZARDS TO THE EQUIPMENT

- Allow the device to reach the surrounding air temperature, not exceeding the following values, before turning the device on:
50 °C (122 °F): GP-4200 Series, GP-4301TW, GP-4401WW, and GP-4501TW DC models.
55 °C (131 °F): GP-4301T, GP-4303T, GP-4401T, GP-4501T/4503T DC models, GP-4500 Series AC models, and GP-4600 Series.
- Do not turn on the device if condensation has occurred inside the device. After it is completely dry again, the device may be turned on.
- Do not expose the device to direct sunlight.
- Do not obstruct the vents in the device casing.
- Remove any dust from the device before turning it on.
- Ensure that the cable installation fasteners are not damaged. Replace them, if necessary.
- Only qualified personnel can change the primary battery.

Failure to follow these instructions can result in injury or equipment damage.

Inquiry

Do you have any questions about difficulties with your GP?
Please access our support site anytime that you need help with a solution.
<http://www.pro-face.com/trans/en/manual/1001.html>

Notes

Please be aware that Digital Electronics Corporation shall not be held liable by the user for any damages, losses, or third party claims arising from the uses of this product.

中国 RoHS 相关资料

(本资料是中国 RoHS 的必备资料。)(This information is essential for China RoHS.)

部件名称 Part Name	有害物质 Hazardous Substances					
	铅 (Pb)	汞 (Hg)	镉 (Cd)	六价铬 (Cr (VI))	多溴联苯 (PBB)	多溴二苯醚 (PBDE)
金属部件 Metal parts	○	○	○	○	○	○
塑料部件 Plastic parts	○	○	○	○	○	○
电子件 Electronic	×	○	○	○	○	○
触点 Contacts	○	○	○	○	○	○
线缆和线缆附件 Cables & cabling accessories	○	○	○	○	○	○

本表格依据 SJ/T 11364 的规定编制。

○：表示该有害物质在该部件所有均质材料中的含量均在 GB/T 26572 规定的限量要求以下。

×：表示该有害物质至少在该部件的某一均质材料中的含量超出 GB/T 26572 规定的限量要求。

This table is made according to SJ/T 11364.

○：Indicates that the concentration of hazardous substance in all of the homogeneous materials for this part is below the limit as stipulated in GB/T 26572.

×：Indicates that concentration of hazardous substance in at least one of the homogeneous materials used for this part is above the limit as stipulated in GB/T 26572.